

Types of Angles

Name: _____

Date: _____

Acute, Obtuse, Right angle and Reflex.

1)

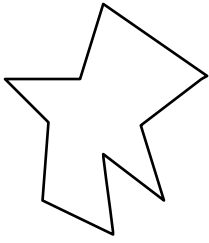

A: _____ O: _____
R: _____ Ref: _____

2)

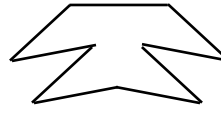

A: _____ O: _____
R: _____ Ref: _____

3)

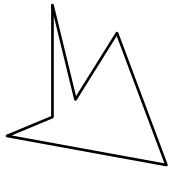

A: _____ O: _____
R: _____ Ref: _____

4)

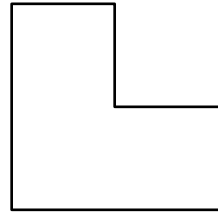

A: _____ O: _____
R: _____ Ref: _____

5)

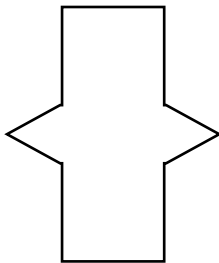

A: _____ O: _____
R: _____ Ref: _____

6)

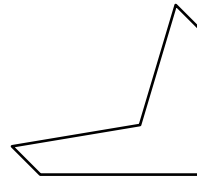

A: _____ O: _____
R: _____ Ref: _____

7)

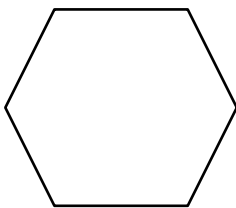

A: _____ O: _____
R: _____ Ref: _____

8)

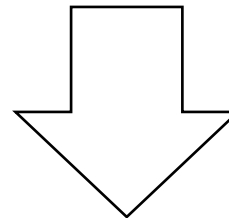

A: _____ O: _____
R: _____ Ref: _____

9)

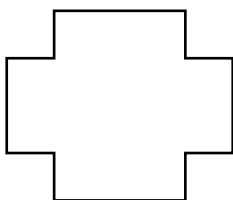

A: _____ O: _____
R: _____ Ref: _____

10)

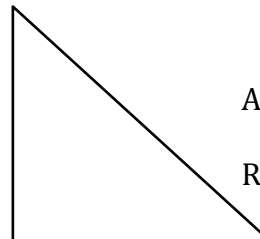

A: _____ O: _____
R: _____ Ref: _____

Types of Angles

Name: _____

Date: _____

Acute, Obtuse, Right angle and Reflex.

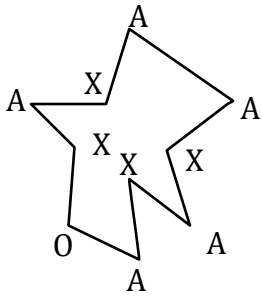
1)  A: 5 O: 1
R: 0 Ref: 4

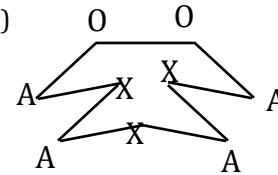
2)  A: 4 O: 2
R: 0 Ref: 3

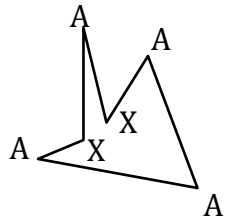
3)  A: 4 O: 0
R: 0 Ref: 2

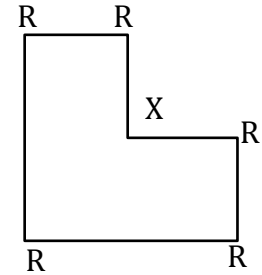
4)  A: 0 O: 0
R: 5 Ref: 1

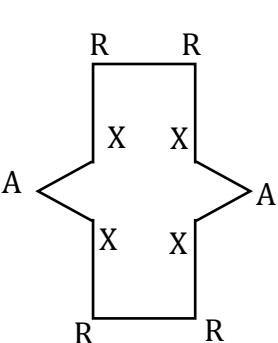
5)  A: 2 O: 0
R: 4 Ref: 4

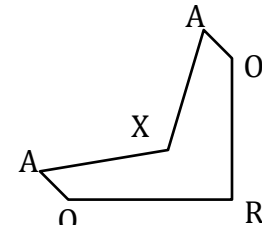
6)  A: 2 O: 2
R: 1 Ref: 1

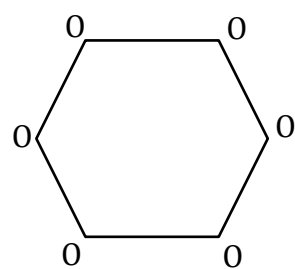
7)  A: 0 O: 6
R: 0 Ref: 0

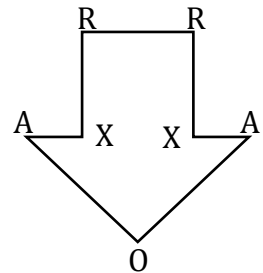
8)  A: 2 O: 1
R: 2 Ref: 2

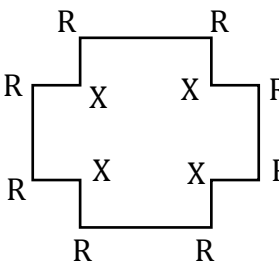
9)  A: 0 O: 0
R: 8 Ref: 4

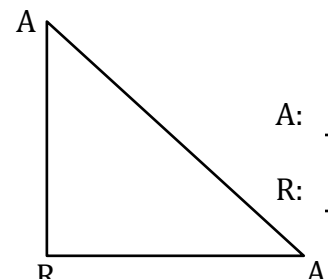
10)  A: 2 O: 0
R: 1 Ref: 0