

Angles

Name: _____

Date: _____

Use protractor to measuring each angle.

1)

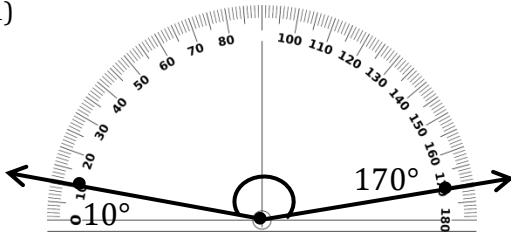

2)

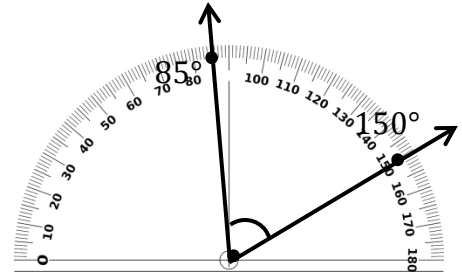

3)

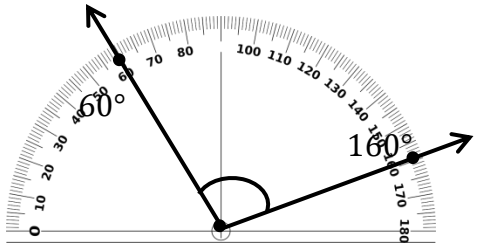

R

4)

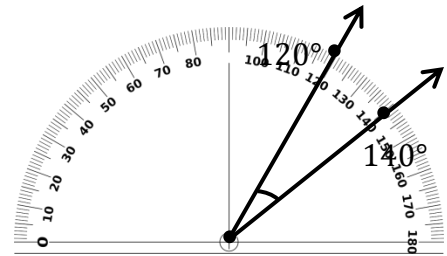

5)

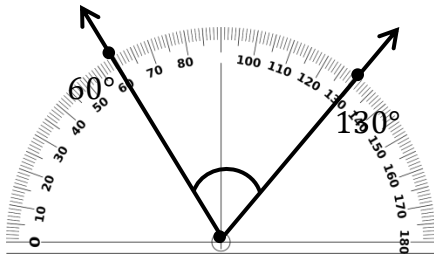

6)

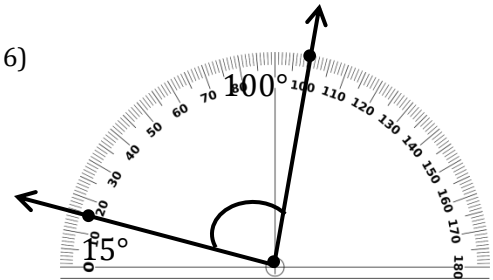

7)

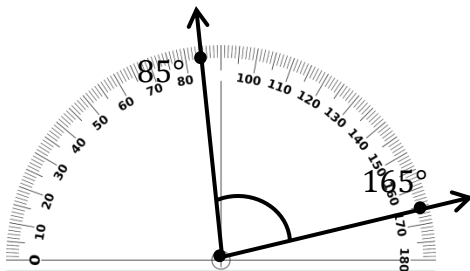

8)

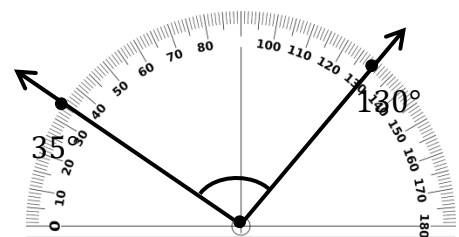

Angles

Name: _____

Date: _____

Use protractor to measuring each angle.

1)

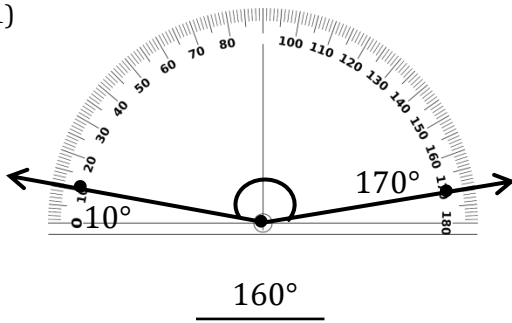

2)

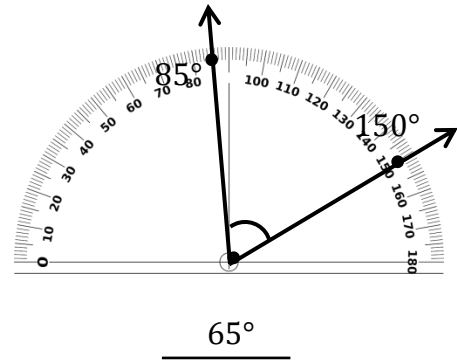

3)

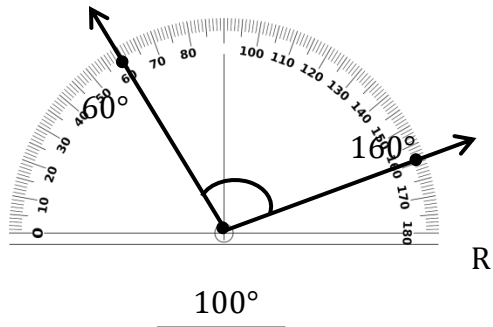

4)

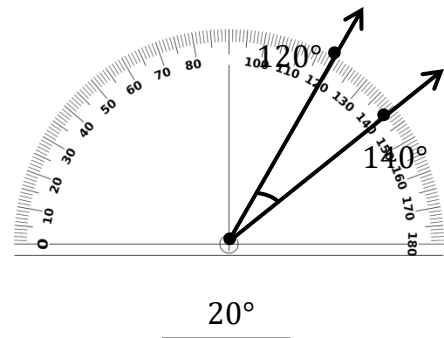

5)

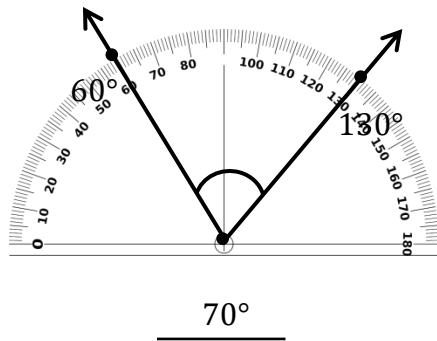

6)

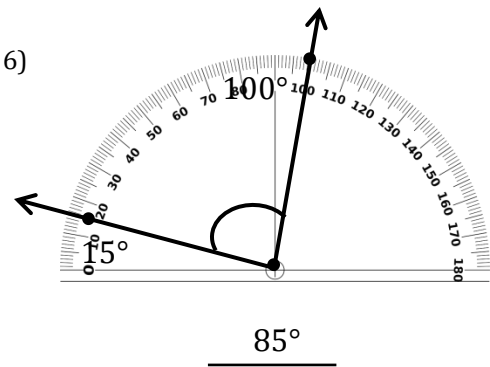

7)

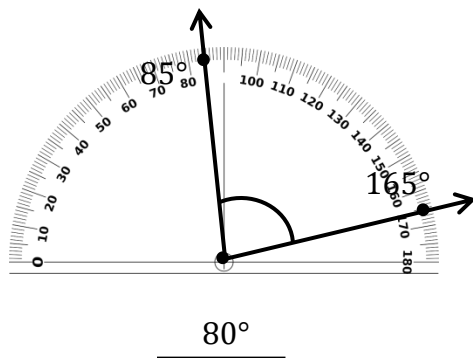

8)

